

Modular Additive Construction Using Native Materials

A. Scott Howe, PhD¹, Brian Wilcox², Chris McQuin³, David Mittman⁴, Julie Townsend⁵,
Raul Polit-Casillas⁶, Todd Litwin⁷

Jet Propulsion Laboratory, California Institute of Technology,
4800 Oak Grove, Pasadena, CA 91109

¹Space Architect, FACS Principal Investigator, a.scott.howe@jpl.nasa.gov

²ATHLETE Principal Investigator, brian.h.wilcox@jpl.nasa.gov

³Mechanical Engineer, Extreme Environment Robots, christopher.mcquin@jpl.nasa.gov

⁴Engineer, Planning & Execution Systems, david.s.mittman@jpl.nasa.gov

⁵Robotics Operations, julie.a.townsend@jpl.nasa.gov

⁶Space Architect, Model-based Engineering, raul.polit-casillas@jpl.nasa.gov

⁷Robotics Software Engineer, telitwin@jpl.nasa.gov

ABSTRACT

Using modular construction equipment and additive manufacturing (3D printing) techniques for binding, mission support structures could be prepared on remote planetary surfaces using native regolith. Material mass contributes significantly toward the cost of deep space missions, whether human or robotic, due to the resources needed to lift each kilogram of equipment out of Earth's gravity well. Proposing the modular Freeform Additive Construction System (FACS) concept, using the reconfigurable All-Terrain Hex-Limbed Extra-Terrestrial Explorer (ATHLETE) robotic mobility platform, a variety of walls, berms, vaults, domes, paving, and thick radiation shielding could be prepared in advance of crews and mission assets to help reduce the material needed to be brought from Earth. This paper discusses the current ATHLETE technology, and describes how flexible mission elements could be derived using a combination of three dimensional additive construction and in-situ manufacturing technologies using native regolith.

Introduction

The challenge of constructing orbital, deep space, and planetary surface space infrastructure has been discussed from a human habitation and space architecture perspective (Howe, Sherwood 2009), and from the perspective of robotic infrastructures (Howe, Colombano 2010). In particular, Howe and Colombano (2010) point out a difference in space manufacturing that may require high precision, and the construction of in-situ structures which may be of a lower resolution. Space manufacturing is more attentive to the properties of specific materials, and may require extraction of more pure elements and powders. Some forms of construction may also require precision tolerance and specific material properties, especially for optimized tensile structures such as pressure vessels, trusses, etc. However, there are certain structures that are mainly compressive in nature that are useful for their bulk and mass, that do not need such precision and may be constructed out of any found material in the environment and still allow for rough surfaces and edges. These compressive in-situ structures could include simple excavations and

berming, or a cruder form of melting and bonding of found materials regardless of what material properties that may be present. We propose a concept for a large-scale 3D additive construction system that would make use of native soils and regolith to construct mission-critical structures. Examples of working systems using large-scale 3D printing have been developed and tested in earth-based structures, and suggested for use on planetary surfaces in space (Khoshnevis, et al, 2005). The technology required for various melting and bonding may require the production of high temperatures and the extraction of local material would need support excavators and material handling only briefly touched upon in this paper.



Figure 1: Freeform Additive Construction System (FACS) concept using ATHLETE

ATHLETE as a Modular Constructor

Using the All-Terrain Hex-Limbed Extra-Terrestrial Explorer (ATHLETE), we propose a concept for a large-scale additive manufacturing system that is capable of producing walls, hard paving, vaults, domes, and a variety of pre-fabricated bricks and other components, using materials extracted from the local environment. This paper discusses the ATHLETE as a construction and mobility platform assuming that native regolith has already been gathered and processed into construction materials, but does not discuss how the gathering and processing would be accomplished. A more detailed discussion of proposed print volumes, work volume, and binder technologies are discussed in Howe, et al (2013).

The ATHLETE is a six-limbed wheel-on-limb robotic mobility platform that is capable of transporting large cargo efficiently on both rolling and rough terrain (Wilcox, et al 2007). The fundamental premise of the ATHLETE system is that for sufficiently large systems, by designing the wheels and wheel actuators for relatively benign terrain, the system saves enough mass to offset the mass of the robotic limbs. A key feature of this design, exploited by FACS, is that these limbs can serve as general-purpose robotic manipulators.

Mechanical System Design:

At the heart of the ATHLETE concept is the limb, which is repeated six times around the body of the robot (Heverly, et al 2010). Each multi-link limb is a six or seven degree-of-freedom (DOF) robotic arm (depending on the number of modular links that have been attached to the chain), consisting of rotary actuators at each joint and lightweight aluminum links between the joints. Each joint consists of an electric motor mated to a high-reduction planetary gearbox and harmonic drive, which provides high torque capability and excellent precision. The torque on each joint is measured and together with the known stiffness of the limb can be used to approximate the true position of the end effector.

Each limb has a general-purpose tool adapter at its tip that allows robotic change-out of tools such as scoops, augers, grippers, or other hardware. Tools can be coupled to the limb's wheel motor, providing a high-power rotary mechanical input.

Control:

ATHLETE's onboard software provides coordinated joint motion, including cartesian positioning of limb end effectors and wheels. Waypoints are used to achieve straight-line paths between cartesian locations. Motions of multiple limbs are also coordinated to enable body positioning. Driving is executed through coordinated control of the wheels and steering actuators, using Ackermann steering solutions to achieve arcing motion. Drive segments are supported in any direction and with any arc, including zero-length arcs which are executed as turns in place. When two Tri-ATHLETES are docked to a cargo pallet, they operate in a master-slave mode, in which motion of all six limbs is coordinated by the master platform.

Operation:

The ATHLETE platform is designed to accommodate a variety of operating paradigms (Townsend & Mittman 2012). For Lunar missions, ATHLETE would be controlled primarily via remote teleoperation from Earth. The ATHLETE robot is teleoperated via a workstation that has both a command uplink and video/telemetry downlink from the robot. A remote operator would maintain good situational awareness through the use of state displays and stereo imagery streamed from ATHLETE's onboard cameras, and would control ATHLETE using computer interfaces or handheld physical controllers tailored to the current task. This philosophy of remote teleoperation could also be implemented for use by an astronaut onboard a Mars or lunar orbiting spacecraft or inside a Mars or lunar surface habitat. Astronauts deployed alongside the ATHLETE platform could operate the robot via local on-site control, making use of gesture recognition or handheld physical interfaces similar to those used by the teleoperators.

Entirely robotic operations to Mars or other locations of significant latency and time delay would take advantage of autonomous operations that have been developed in the operations of Jet Propulsion Laboratory (JPL)'s rover control and operations platform implemented in the Mars Exploration Rover (MER) Spirit and Opportunity rovers, and improved on Mars Science Laboratory (MSL) Curiosity rover.

Computer Vision:

As a 3D printing tool, a stationary ATHLETE moving only one of its limbs in a work envelope would produce the most accurate structures. Shifting the vehicle while remaining stationary would create a larger work volume, but may introduce some inaccuracies. Finally, driving the

vehicle on the surface would expand the printable work volume to be virtually over the entire planetary surface, but could open up the possibility for larger errors in the knowledge of the vehicle's own pose. Since the robot would be operating in a chaotic environment, it will be important to restructure the environment in such a way that errors and inaccuracies in navigation can be reduced or eliminated within an acceptable tolerance.

Computer vision can address 1) where on the ground (full pose: position and orientation) is the structure to be built, and how can the autonomous system know where it is in relation to that target structure, 2) what portion of the structure has been built so far – how much construction material has been placed on the ground and what shape does it take, 3) where is the print head in relation to the proposed structure and completed portions?

The geometry of the vehicle, construction site, and environment over time would be kept track of in relation to the rover frame of reference. One or more visual targets will be placed on the print head so that its pose in rover frame can be determined by computer vision techniques. Unique patterns of high-contrast dots (Litwin 2005) or color patterns (Volpe, Litwin, Matthies 1995; Wilcox, et al 2007) would be placed in convenient, visible locations to determine the location of various objects and robot geometries that vary over time. The ATHLETE vehicle, individual limbs, and print head would be tracked in this way to keep fine-grained precision positioning on track in relation to each other.

Initially ATHLETE would use its own notion of position in regards to the environment. Current techniques for this use a combination of dead reckoning, IMU measurements, visual odometry, and localization based on sightings of the Sun. These techniques are designed for large-scale navigation and therefore would not be enough for the kind of fine-grained positioning needed for additive construction work. To bridge the gap between large-scale environmental navigation and fine-grained positioning, portable visual targets will be placed on the ground around the construction site away from the activity, that would remain until the construction is complete. Once construction is complete, the visual targets can be gathered by ATHLETE and stowed, or moved to a new construction site.

In order for ATHLETE and the printing system to keep track of itself in relation to completed portions of the structure, shape would need to be determined and tracked. Current techniques for shape tracking include stereo vision access and inspection of all the surfaces to produce a mesh of 3D points describing the surface (Howard, et al 2009). The resulting mesh surface can be compared to a CAD model to determine which parts, within a target resolution, do not match the material coverage in the planned structure. A procedure for site acquisition, orientation, completed structure inspection, and calibration would allow the additive construction process to be interrupted and restarted again if the ATHLETE needs to be called away for higher priority tasks.

Freeform Additive Construction System (FACS):

The proposed Freeform Additive Construction System (FACS) would function as an onsite robotic construction tool that does not require the presence of human operators, but can alternatively function at the direction of onsite human crews (Howe, et al 2013). The FACS system is an additive manufacturing system that would be capable of "3D printing" large-scale walls, paving, vaults, domes, and hardening trench walls. The acronym comes from the idea of faxing CAD models remotely to the additive manufacturing printer onsite, to allow the construction and build-up of in-situ structures autonomously and via remote control. Figure 1 shows one possible

configuration of the FACS system, with deployable solar arrays for power needed to achieve the high temperatures required at a print head.

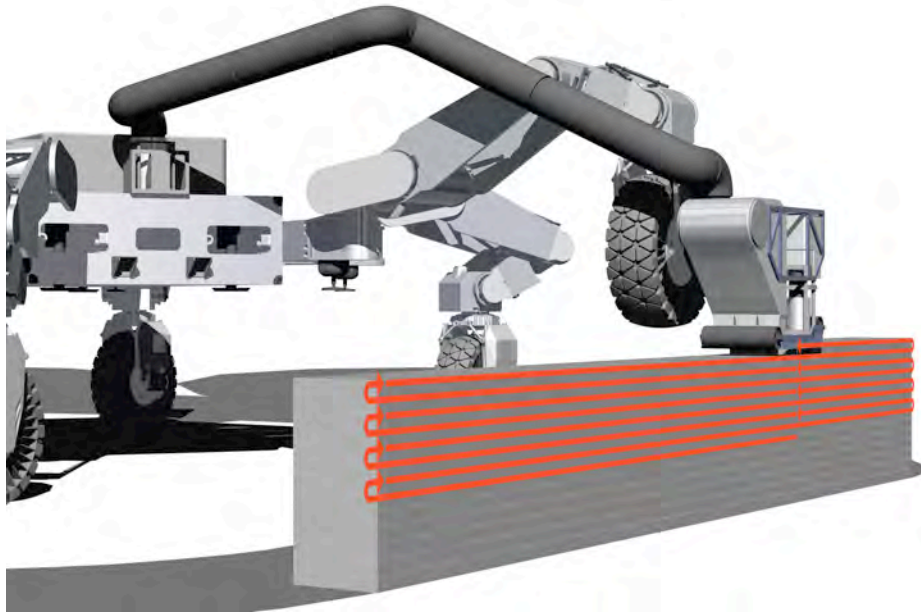

Figure 2: native soil or regolith deposited in layers similar to a desktop 3D printer

All structures that would be printed using the FACS system would need to begin as a CAD model, dissected into layers that can be continuously laid (Figure 2) by the print head (similar to machine code for a desktop plastic 3D printer). For large structures, the ATHLETE platform would need to reposition itself multiple times during the printing process to fulfill the orientation and access requirements for the print head at various points on the structure. The machine code for printing the structure would include numerous potential stopping points away from critical geometries, where the FACS system can stop, reposition the ATHLETE platform, and continue adding material with the print head. ATHLETE can be called away for higher-priority tasks at these points.

Pre-operational scenario would include:

- Ground survey of potential construction sites and selection of site
- Analysis (core samples, etc) to determine capacity of ground to support structure
- Modification / customization of stock CAD model of structure to add more or less foundation as needed
- Placement of visual markers around proposed construction site
- Limited excavation (by ATHLETE or other vehicles) to expose stable soil as needed
- Identification of excavation site for construction material source

Assuming excavation equipment (Mueller & King 2008) support, the operational scenario of the FACS system would be as follows:

- Inspection and capture of existing structure (if any) via 3D mesh
- Comparison of 3D mesh to CAD model of proposed finished structure
- Placement of ATHLETE at a pre-determined “begin” point (or where it left off)
- Establishment of material handling chain and support vehicles (transport and excavation)

- Begin printing based on pre-established path, or continuation of where it left off
- Reach a stopping point
- Evaluate whether higher-priority tasks have been received or not – if so, stop printing and move away from construction site to complete the task
- Evaluate whether print head can continue printing to the next stopping point without repositioning ATHLETE – if not, stop printing and reposition
- Continue printing, capturing new geometry via 3D mesh

Constructing Mission-critical Structures Using Native Regolith

One of the key aspect in using Additive Construction (AC) techniques is the type of geometries that can be implemented. Using AC allows the creation of geometries driven by environmental factors (for instance gravity values, thermal properties, accessibility, etc) as well as radiation shielding capabilities. Using advance Building Information Modeling (BIM) techniques it would be possible to read and scan the terrain, introduce that information in the model, and create geometries using algorithmic parametrical models, or importing from previous models in a repository. Following the current state of the art design processes and being able to implement BIM with a versatile robotic platform like ATHLETE would allow us to push the limits of robotic construction on other planetary surfaces as well as on Earth. At the same time these techniques allow us to simulate models before we print them and make sure the final outcome is the most optimized. Data capturing technologies allow for checking the process in real-time for comparison with our virtual building of the habitat. The use of additive construction also allows the performance of research with the use of the same material but different geometries to improve thermal, radiation shielding, etc as well as to combine materials in order to create more efficient but continuous envelopes.

The most mission-critical structures to support human crews will be shielded habitats, that mitigate the risk of health issues caused by Galactic Cosmic Radiation (GCR) or other environmental hazards. Since effective radiation shielding would be prohibitive to transport up out of Earth's gravity well, it will be cost-effective to develop and deliver equipment that can process native material into the type of shielded structures required for human crews. A simple execution of radiation structure might be to create a vaulted unpressurized garage upon which loose regolith can be piled on top to the required thickness – the habitat can be transported from the lander into the garage using a mobility system (ATHLETE or some other system), and set in place under the shielding.

A second mission-critical element might save some of the complexity and risks of long-distance relocation of multiple mission manifests by building hard landing pads that avoid creating ejecta. NASA's Human Architecture Team (HAT) Evolvable Mars Campaign work determined that multiple landers for outpost buildup would need to land kilometers apart to avoid damaging ("sandblasting" through ejecta) previously placed elements. This requirement puts an added strain on equipment required for outpost build-up, where elements must be transported great distances across the surface before they can be docked or connected together. Therefore, if FACS and excavation equipment were delivered on the first mission, landing pads could be constructed side-by-side for subsequent missions, thus simplifying the build-up of the outpost.

Rough, preliminary mass has been estimated for a FACS system using microwave sintering technology (Barmatz, et al, 2013) and solar concentrator technology (Nakamura & Smith 2011), shown in Figure 3.



FACS "Sinterator"

	mass kg	mass total
ATHLETE		1,598.4
Triangle (2x)	193.8	387.6
Leg (6x)	201.8	1,210.8
Pallet		487.7
Body		157.0
Collector	41.3	41.3
Grinder	38.0	38.0
Sifter	37.2	37.2
Conduit	46.4	46.4
Handler	24.5	24.5
Avionics	130.0	130.0
Holster	3.1	3.1
Interface (2x)	5.1	10.3
Umbilical		45.7
Conduit (4x)	9.1	36.4
Elbow (2x)	4.7	9.3
Print Head Sinterator		30.1
Elbow	4.7	4.7
Frame	5.1	5.1
Tool Grasp	0.2	0.2
Hopper	3.1	3.1
Avionics	2.0	2.0
Roller (2x)	2.0	4.0
Magnetron (3x)	3.7	11.0
Power		600.0
	Growth 20%	552.4
Total		3,314.3

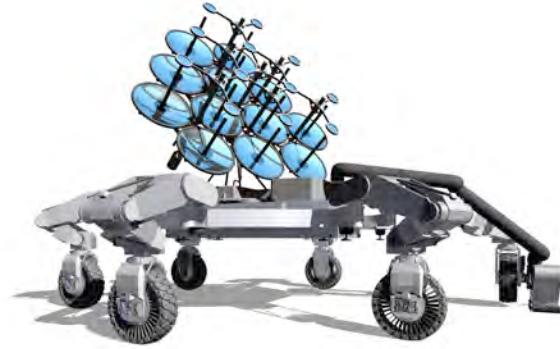

FACS Solar Concentrator

	mass kg	mass total
ATHLETE		1,598.4
Triangle (2x)	193.8	387.6
Leg (6x)	201.8	1,210.8
Pallet		487.7
Body		157.0
Collector	41.3	41.3
Grinder	38.0	38.0
Sifter	37.2	37.2
Conduit	46.4	46.4
Handler	24.5	24.5
Avionics	130.0	130.0
Holster	3.1	3.1
Interface (2x)	5.1	10.3
Umbilical		45.7
Conduit (4x)	9.1	36.4
Elbow (2x)	4.7	9.3
Print Head Concentrator		25.6
Elbow	4.7	4.7
Frame	5.1	5.1
Tool Grasp	0.2	0.2
Hopper	3.1	3.1
Avionics	1.0	1.0
Roller (2x)	2.0	4.0
Focal Fixture (3x)	2.5	7.5
Solar Concentrator		436.5
Power		200.0
	Growth 20%	558.8
Total		3,352.7

Figure 3: Preliminary mass estimates for a microwave "Sinterator" (left) and solar concentrator (right) FACS system concepts

Advanced Modular Construction Systems

The FACS system could be used in a variety of applications, such as paving, surface stabilization, berm / trench wall stabilization, and to print walls and overhangs. An example of printing a large-scale vaulted shell enclosure, using techniques pioneered by the University of Southern California Contour Crafting team (Khoshnevis, et al, 2005). In this paper, we propose a modular method for construction of vaults, support structure, and paving that requires less precision positioning of the FACS system during the 3D printing stage – prefabrication of construction panels.

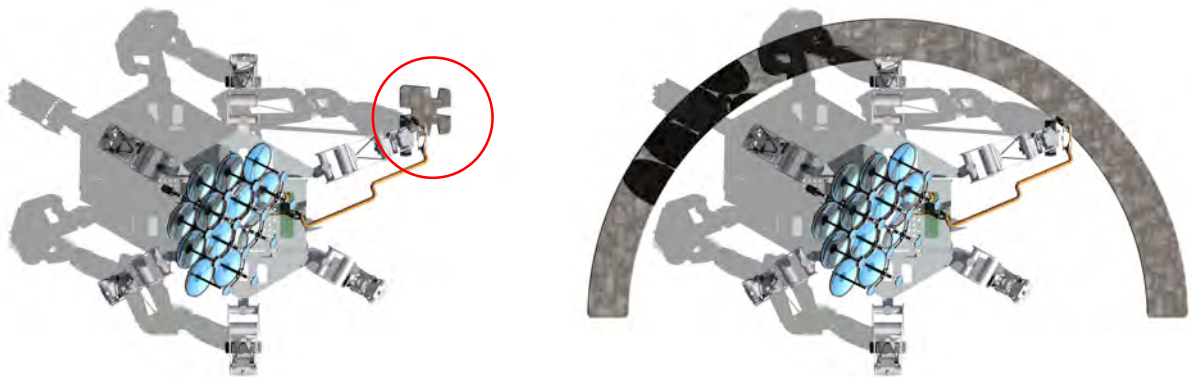

Figure 4: Additive manufacture of prefabricated elements -- small modular panels (left), and large beams (right) printed on the ground

Modular panels (Figure 4, left), beams (Figure 4, right), or other construction elements could be printed on a smooth stretch of ground to a desired thickness with or without reinforcement. Once a sufficient supply of panels have been manufactured and stacked to the side, ATHLETE can lift and manipulate the panels into temporary scaffolding or self-standing support structures (Figure 5).

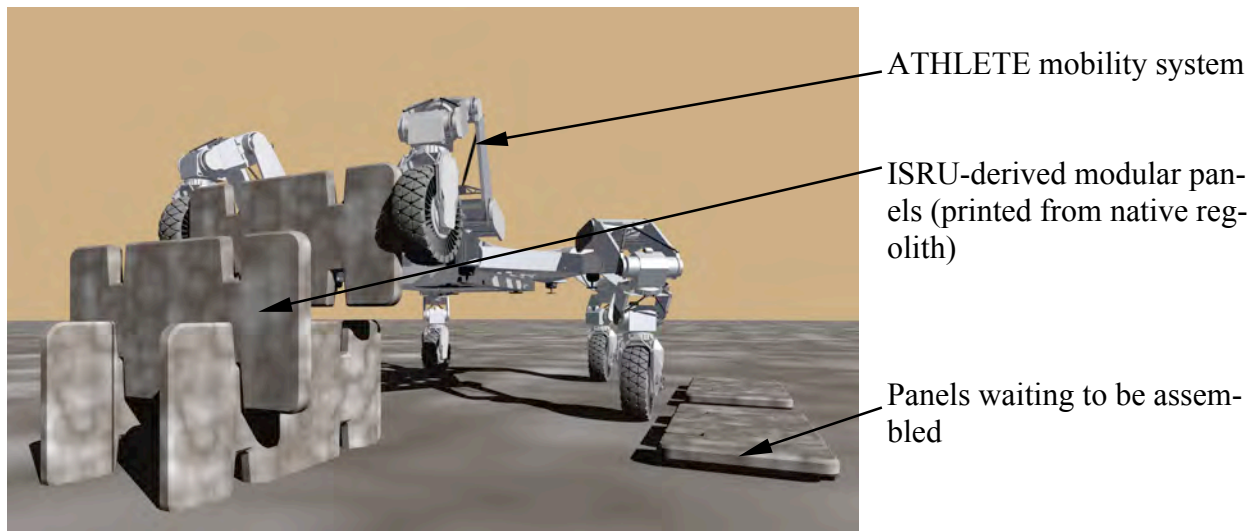

Figure 5: Using ATHLETE as lifting and construction equipment to assemble scaffolding or self-standing modular support structures

Using a modular approach, large beams, small panels, modular-derived structures (Figure 6, left), or landing pad pavers (Figure 6, right) could be printed and placed later when needed. ATHLETE could be used to tilt-up prefabricated panels, using scaffolding and support structure to temporarily keep them in place (Figure 7).

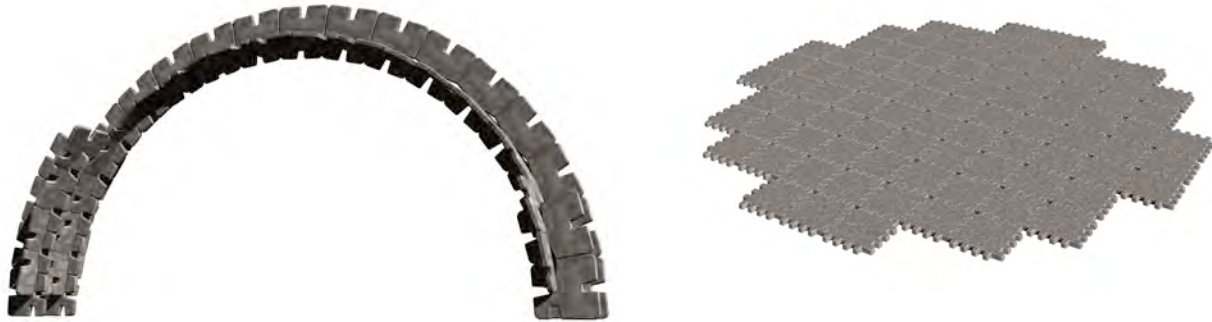

Figure 6: Small, modular panel-derived vault arch structure may require temporary scaffolding during assembly (left), and landing pad constructed of prefabricated pavers laid in place (right)

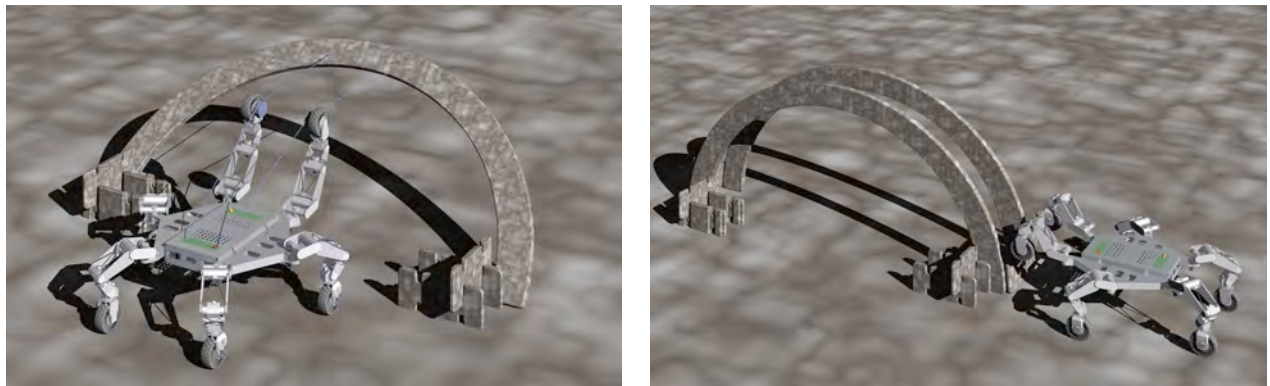

Figure 7: Tilt-up construction of complete monolithic prefabricated beams and arches (left), and placement of prefabricated panels (right)

A vaulted, unpressurized garage can be assembled one panel at a time (Figure 8, left), and buried later with the right depth of regolith to provide enough radiation shielding for crews (Figure 8, right).

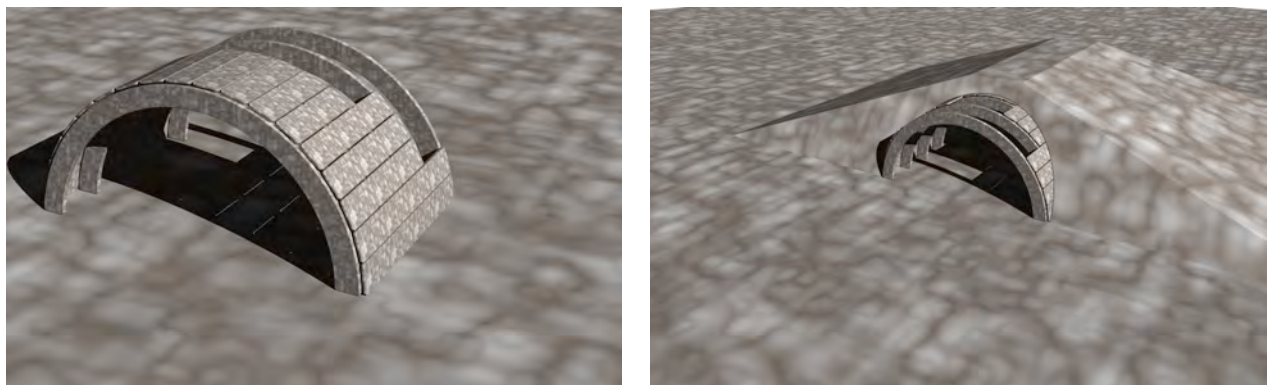

Figure 8: Partially constructed unpressurized garage (left), buried with regolith in a bunker-style for radiation protection of crews (right)

When the crew arrives, the ATHLETE mobility system could carry habitat elements under the vault (Figure 9), lower the habitat onto self-leveling legs, detach (Figure 10), and leave the operational habitat in a protected environment (Figure 11). The unpressurized garage could be constructed in

a shallow crater giving added protection from the ends, or excavation equipment can construct berms for that purpose.

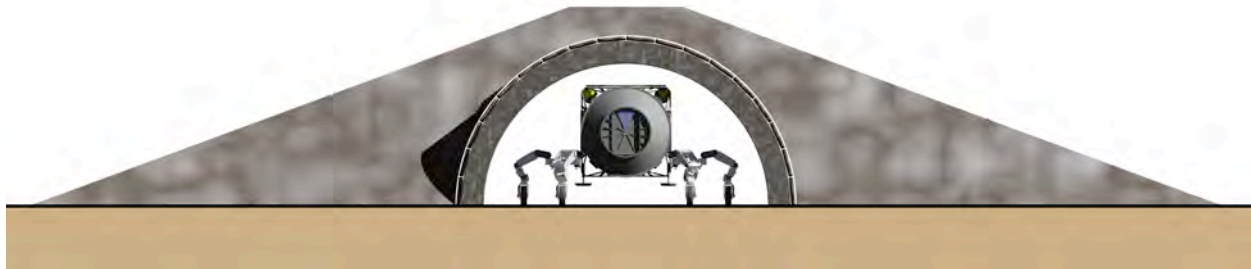

Figure 9: Habitat would be carried into unpressurized garage via ATHLETE mobility system

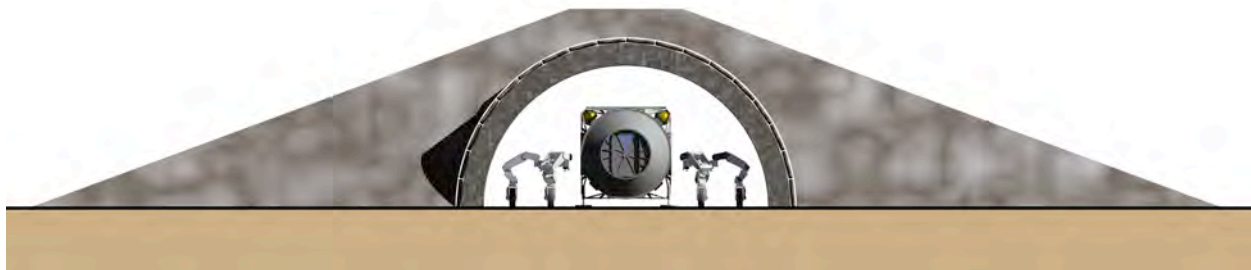

Figure 10: Once habitat is lowered onto self-leveling feet, ATHLETE could detach and move onto other tasks

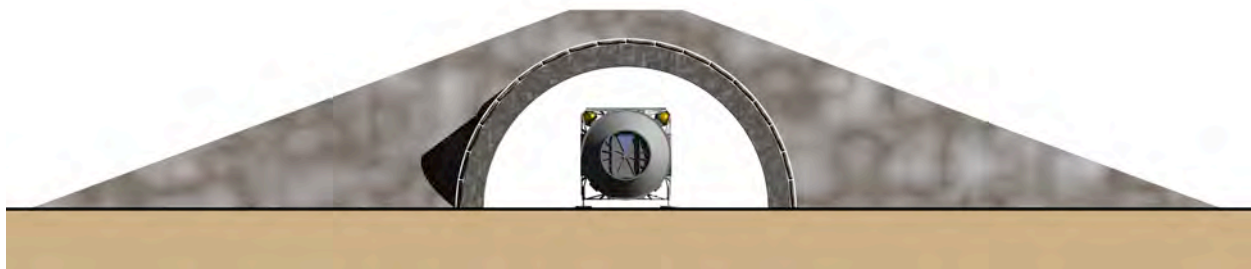

Figure 11: Habitat would be protected from radiation and micrometeorites using native structures and regolith

The unpressurized garage used in this example could shield a habitat 3m in diameter by up to 20m long. The mass of the printed shielding material, assuming to be of a similar density to concrete at $2,300\text{kg/m}^3$ becomes 86,898kg for 14 curved arches, plus 153,036kg for 234 panels (1m x 2m). Add the material buried on top, using a density of gravel and sand at $1,920\text{kg/m}^3$ becomes 4.5 million kilograms of material, making a total of 4.7 million kilograms of radiation shielding. Putting this in perspective, if the same amount of shielding material were to be brought up out of Earth's gravity well, assuming \$1 million/kg landed mass on Mars, the cost for this one structure alone would exceed 4.7 trillion dollars, which is almost one-third of the entire gross national product of the United States in 2013 (Gross National Product 2013). A trade off of 3.5 tons for a FACS-type constructor that could build an unlimited number of shielded structures and landing pads should be an obvious investment choice for immediate development and implementation.

Conclusion

If crew health and protection is important in a long-duration surface mission, a regolith construction system such as the ATHLETE-derived Freeform Additive Construction System (FACS) could literally save trillions of dollars in equivalent mass that would need to be brought up out of Earth's gravity well. In addition, the capacity to print landing pads near the location where the outpost is to be built up would shorten the delivery distance of habitation modules, cargo, equipment, and logistics from landers that otherwise would need to be scattered over many kilometers distance. It is recommended that regolith construction capacity be considered right from the start in human Mars missions, along with in-situ derived rocket fuel.

In addition, a FACS-type construction system would be applicable on Earth in remote locations and hazardous environments such as war zones, natural disaster areas, radiation confinement, and third-world infrastructure build-up.

Acknowledgments

Special thanks to Kennedy Space Center Swamp Works, University of Southern California Contour Crafting team, and Takashi Nakamura for their collaboration and discussions.

The research described in this paper was carried out at the Jet Propulsion Laboratory, California Institute of Technology, under a contract with NASA. Copyright 2014. All rights reserved.

References

M Barmatz; D Steinfeld; D Winterhalter; D Rickman; M Weinstein (2013). Microwave Heating Studies and Instrumentation for Processing Lunar Regolith and Simulants. *44th Lunar and Planetary Science Conference*. Woodlands, Texas, USA, 18 – 22 Mar 2013. Houston, Texas, USA: Lunar and Planetary Institute.

Gross National Product (2013). In *Wikipedia, The Free Encyclopedia*. Retrieved 1 Aug 2014, from http://en.m.wikipedia.org/wiki/Gross_national_product

M Heverly; J Matthews; M Frost; C McQuin (2010). Development of the Tri-ATHLETE Lunar Vehicle Prototype. *40th Aerospace Mechanisms Symposium*. NASA Kennedy Space Center, Cocoa Beach, Florida, USA, 12 – 14 May 2010.

A Howard; A Ansar; T Litwin; S Goldberg (2009). Robot Vision Library. Indelible Systems for NASA's Jet Propulsion Laboratory. *NASA Tech Briefs*, Sep 2009, p23.

AS Howe; B Wilcox; C McQuin; J Townsend; R Rieber; M Barmatz; J Leichty (2013). Faxing Structures to the Moon: Freeform Additive Construction System (FACS) (AIAA2013-5437). *AIAA Space 2013 Conference & Exhibition*. San Diego, California, USA, 10-12 Sep 2013. Reston, Virginia, USA: American Institute of Aeronautics and Astronautics.

AS Howe; S Colombano (2010). The Challenge of Space Infrastructure Construction (AIAA2010-8619). *AIAA Space 2010 Conference & Exhibition*. Anaheim, California, USA, 30 Aug - 2 Sep 2010. Reston, Virginia, USA: American Institute of Aeronautics and Astronautics.

AS Howe & B Sherwood (eds.) (2009). *AIAA History of Spaceflight series, Out of This World: The New Field of Space Architecture*, ISBN 978-1-56347-982-3. Reston, Virginia, USA: American Institute of Aeronautics and Astronautics.

B Khoshnevis; P Bodiford; KH Burks; E Ethridge; D Tucker; W Kim; H Toutanji; MR Fiske (2005). Lunar Contour Crafting: A Novel Technique for ISRU based Habitat Development (AIAA2005-538). *AIAA Aerospace Sciences Meeting*. Reno, Nevada, USA, 10 - 13 Jan 2005.

T Litwin (2005). General 3D Acquisition and Tracking of Dot Targets on a Mars Rover Prototype. *IEEE International Conference on Systems, Man, and Cybernetics*. Big Island, Hawaii, October 10-12, 2005.

RP Mueller; RH King (2008). Trade Study of Excavation Tools and Equipment for Lunar Outpost Development and ISRU. *Space Technology and Applications International Forum (STAIF2008)*. Albuquerque, New Mexico, USA, 10 – 14 Feb 2008. Proceedings, pp 237-244. Melville, New York, USA: American Institute of Physics AIP Press.

T Nakamura; B Smith (2011). Solar Thermal System for Lunar ISRU Applications: Development and Field Operation at Mauna Kea, HI (AIAA2011-433). *49th AIAA Aerospace Sciences Meeting / New Horizons Forum and Aerospace Exposition*. Orlando, Florida, USA, 4 – 7 Jan 2011. Reston, Virginia, USA: American Institute of Aeronautics and Astronautics.

J Townsend; D Mittman (2012). Driving ATHLETE: Analysis of Operational Efficiency (AIAA2012-5116). *AIAA Space 2012 Conference & Exhibition*. Pasadena, California, USA, 11 – 13 Sep 2012. Reston, Virginia, USA: American Institute of Aeronautics and Astronautics.

R Volpe; T Litwin; L Matthies (1995). Mobile Robot Localization by Remote Viewing of a Colored Cylinder. *IEEE Conference on Robots and Systems (IROS)*. Pittsburgh, Pennsylvania, USA, Aug 5-9, 1995.

BH Wilcox; T Litwin; J Biesiadecki; J Matthews; M Heverly; J Townsend; N Ahmad; A Sirota; B Cooper (2007). ATHLETE: A Cargo Handling and Manipulation Robot for the Moon. *Journal of Field Robotics*, Vol 24, No 5, pp 421-434.